

High Efficiency, High Density, Switched Capacitor Converter for High Power Applications

Jian Li, Jeff Zhang, Ya Liu, and Marvin Macairan
Analog Devices, Inc.

The power density of a dc-to-dc converter is generally limited by bulky magnetic components, especially in applications where the input and output voltages are relatively high. Inductor/transformer size can be reduced by increasing the switching frequency, but this reduces converter efficiency because of switching-related losses. It is better to eliminate the magnetics altogether with an inductorless switched capacitor converter (charge pump) topology. Charge pumps can increase power density as much as 10× over a conventional converter without sacrificing efficiency. Instead of an inductor, a flying capacitor stores and transfers the energy from input to output. Despite the advantages of charge pump designs, switched capacitor converters are traditionally limited to low power applications, due to the challenges presented in startup, protection, gate drive, and regulation.

The **LTC7820** is a fixed ratio, high voltage, high power switched capacitor controller that yields small and cost-effective solutions for high power, non-isolated intermediate bus applications with fault protection. The LTC7820's features include:

- ▶ Low profile, high power density, capable of 500 W+
- ▶ V_{in} max for voltage divider (2:1): 72 V
- ▶ V_{in} max for voltage doubler (1:2)/inverter (1:1): 36 V
- ▶ Wide bias V_{cc} range: 6 V to 72 V
- ▶ Soft switching: 99% peak efficiency and low EMI
- ▶ Soft startup into steady state operation
- ▶ Input current sensing and overcurrent protection
- ▶ Integrated gate drivers
- ▶ Output short-circuit/OV/UV protection with programmable timer and retry
- ▶ Thermally enhanced 28-lead 4 mm × 5 mm QFN package

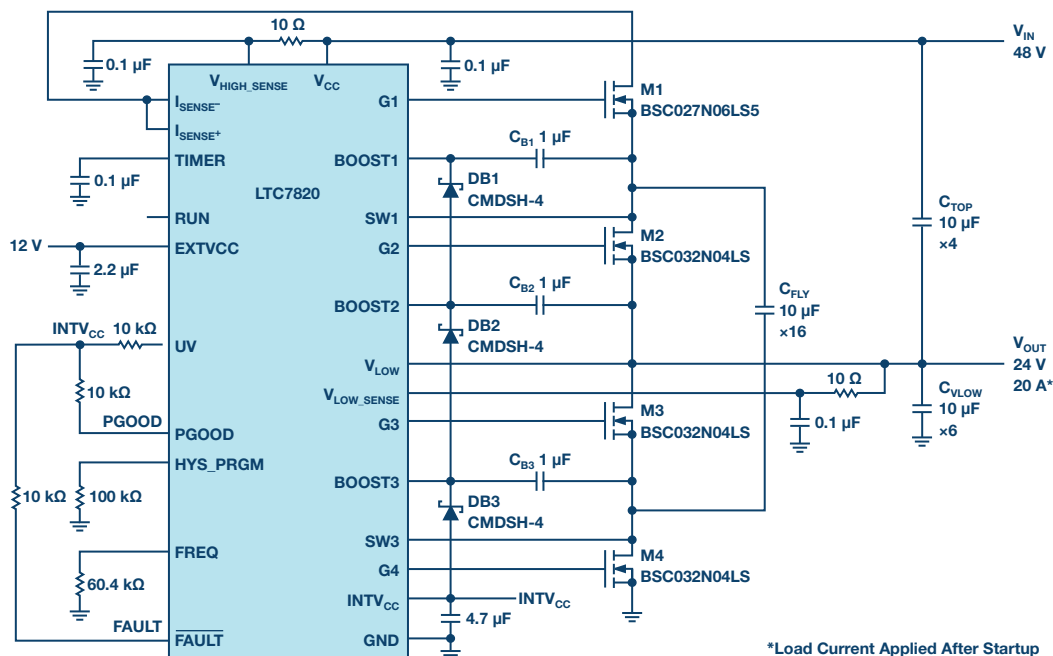

*Load Current Applied After Startup

Figure 1. A 48 V to 24 V/20 A voltage divider with a power density of 4000 W/in².

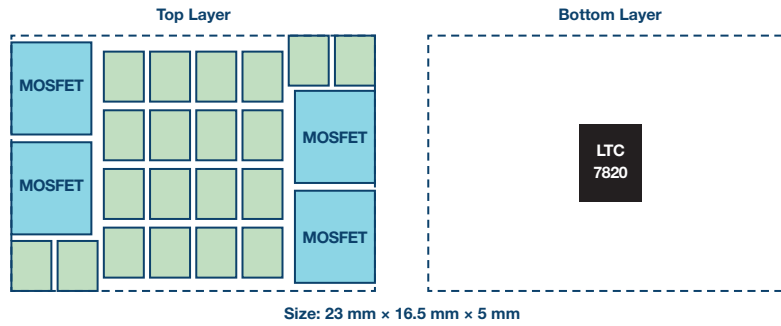

Figure 2. Estimated solution size features 5 mm maximum height.

48 V to 24 V/20 A Voltage Divider with Power Density of 4000 W/In³

Figure 1 shows a 480 W output voltage divider circuit featuring the LTC7820. The input voltage is 48 V and the output is 24 V at up to 20 A load. Sixteen 10 μ F ceramic capacitors (1210 size) act as a flying capacitor to deliver the power. The approximate solution size is 23 mm \times 16.5 mm \times 5 mm as shown in Figure 2 and the power density is as high as 4000 W/in³.

High Efficiency

Since there is no inductor used in the circuit, all four MOSFETs are soft switched, greatly reducing switching-related losses. The converter can achieve high efficiency as shown in Figure 3, where the peak efficiency is 99.3% and the full load efficiency is 98.4%. The thermograph in Figure 4 shows a balanced thermal design with a hot spot temperature about 82.3°C in an ambient environment of 23°C and no forced airflow.

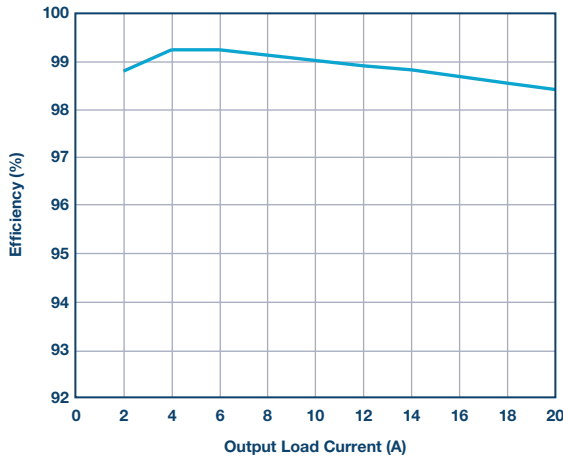

Figure 3. Efficiency at 48 V input, 24 V output, and a 200 kHz switching frequency.

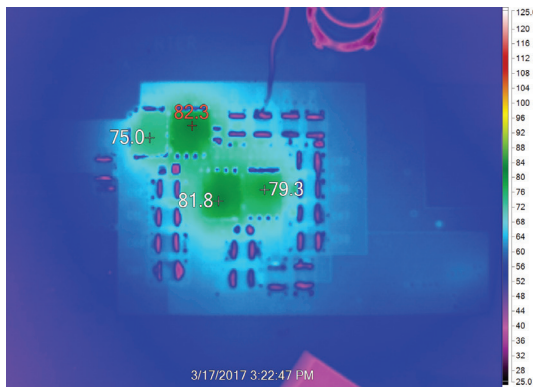

Figure 4. Thermal test at 48 V input, 24 V output at 20 A, and 200 kHz switching frequency.

Prebalance Prevents Inrush Currents

In addition to impressive efficiency and thermal performance, the LTC7820 includes a proprietary prebalance method to minimize inrush current in voltage divider applications. The LTC7820 controller detects the V_{LOW_SENSE} pin voltage before switching and compares it with the $V_{HIGH_SENSE}/2$ internally. If the voltage at the V_{LOW_SENSE} pin is much lower than $V_{HIGH_SENSE}/2$, a current source injects 93 mA of current at the V_{LOW} pin to pull V_{LOW} up. If the voltage at V_{LOW_SENSE} is much higher than $V_{HIGH_SENSE}/2$, another current source sinks 50 mA from V_{LOW} to pull it down. If the voltage at V_{LOW_SENSE} is near $V_{HIGH_SENSE}/2$, that is, within the preprogrammed window, both current sources are disabled and the LTC7820 starts switching.

Figure 5 shows the enormous input inrush current that occurs at start-up without precharging—more than enough to damage the MOSFETs and capacitors. In contrast, no excessive inrush current is observed after the prebalance method is applied, as shown in Figure 6.

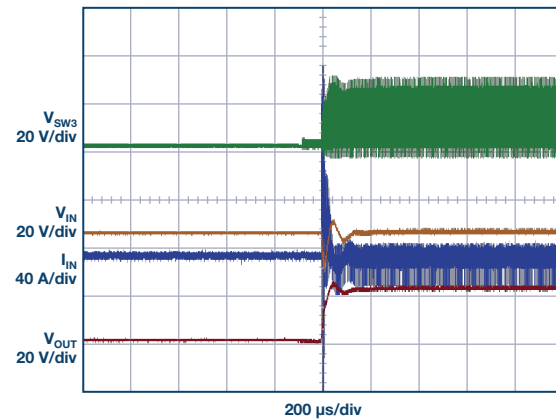

Figure 5. Start-up waveform without prebalance shows large inrush current.

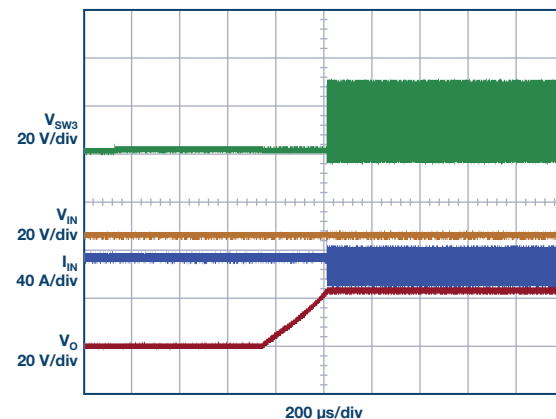

Figure 6. Startup waveform with LTC7820 prebalance shows elimination of inrush current.

Tight Load Regulation

Even though the LTC7820-based voltage divider is an open-loop controlled converter, load regulation is tight due to its high efficiency. As shown in Figure 7, the output voltage drops only 1.7% at full load.

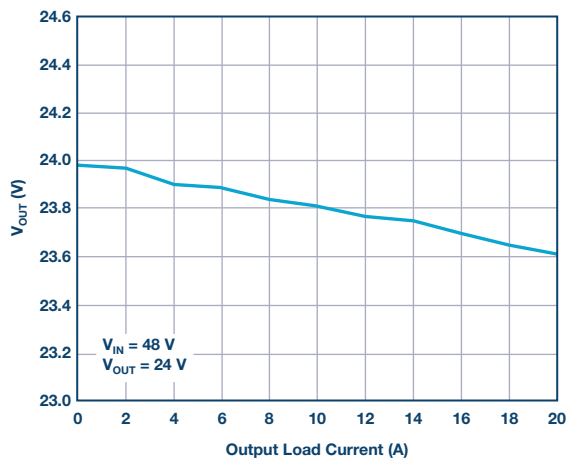

Figure 7. Load regulation.

Protection Features

The LTC7820 includes protection features to ensure high converter reliability. Overcurrent protection is enabled through a sensing resistor on the high voltage side. A precision rail-to-rail comparator monitors the differential voltage between the I_{SENSE+} pin and the I_{SENSE-} pin, which are Kelvin connected to a sensing resistor. When the voltage at I_{SENSE+} is 50 mV higher than the I_{SENSE-} , an overcurrent fault is triggered, the FAULT pin is pulled down to ground, and the LTC7820 stops switching and starts retry mode based on the timer pin setup.

Further protection is available through the OV/UV window comparator. In normal operation, the voltage at V_{LOW_SENSE} should approach half of V_{HIGH_SENSE} . A window comparator monitors V_{LOW_SENSE} and compares it to $V_{HIGH_SENSE}/2$. The hysteresis window voltage can be programmed and is equal to the voltage at the HYS_PRGM pin. With a 100 k Ω resistor on the HYS_PRGM pin, the $V_{HIGH_SENSE}/2$ voltage must be within a ($V_{LOW_SENSE} \pm 1$ V) window during start-up and normal operation. Otherwise a fault is triggered and the LTC7820 stops switching.

Conclusion

The LTC7820 is a fixed ratio high voltage, high power switched capacitor controller that meets the power density demands of bus converters, high power distributed power systems, communications systems, and industrial applications. No inductors are needed.

About the Authors

Jian Li received his M.S. degree in control theory and control engineering from Tsinghua University, China, in 2004, and a Ph.D. degree in power electronics from Virginia Tech, United States, in 2009. At present, he is an applications engineering manager for power products at Analog Devices. He holds nine U.S. patents and has published over 20 transaction and conference papers. He can be reached at jian.li@analog.com.

Xu (Jeff) Zhang was born in Beijing, China. He received his B.S. and M.S. degrees in electrical engineering from Tsinghua University and his Ph.D from University of Colorado at Boulder. He joined Linear Technology (now Analog Devices) in 2010 and is currently a power IC design engineer in the Power by Linear™ Group. He can be reached at xu.zhang@analog.com.

Ya Liu is a senior application engineer with Analog Devices in the power products applications group in Milpitas, California. Currently, he is the primary applications support for switch-capacitor converters and hybrid converters. He also supports PSM controllers and analog buck controllers. Ya Liu received his B.S. degree from Zhejiang University, Hangzhou, China, and an M.S. degree from Virginia Polytechnic Institute and State University (Virginia Tech), Blacksburg, both in electrical engineering. He is the holder of two Chinese patents and three U.S. patents. He can be reached at ya.liu@analog.com.

Marvin Macairan is currently an associate applications engineer for Analog Devices' Power by Linear™ application group. He is responsible for supporting application engineers and optimizing demo boards that highlight ADI power products. He attained an M.S. in electrical engineering from California Polytechnic State University, San Luis Obispo. He can be reached at marvin.macairan@analog.com.

Online Support Community



Engage with the Analog Devices technology experts in our online support community. Ask your tough design questions, browse FAQs, or join a conversation.

Visit ez.analog.com

Analog Devices, Inc. Worldwide Headquarters

Analog Devices, Inc.
One Technology Way
P.O. Box 9106
Norwood, MA 02062-9106
U.S.A.
Tel: 781.329.4700
(800.262.5643, U.S.A. only)
Fax: 781.461.3113

Analog Devices, Inc. Europe Headquarters

Analog Devices GmbH
Ott-Aicher-Str. 60-64
80807 München
Germany
Tel: 49.89.76903.0
Fax: 49.89.76903.157

Analog Devices, Inc. Japan Headquarters

Analog Devices, KK
New Pier Takeshiba
South Tower Building
1-16-1 Kaigan, Minato-ku,
Tokyo, 105-6891
Japan
Tel: 813.5402.8200
Fax: 813.5402.1064

Analog Devices, Inc. Asia Pacific Headquarters

Analog Devices
5F, Sandhill Plaza
2290 Zuchongzhi Road
Zhangjiang Hi-Tech Park
Pudong New District
Shanghai, China 201203
Tel: 86.21.2320.8000
Fax: 86.21.2320.8222

©2019 Analog Devices, Inc. All rights reserved. Trademarks and registered trademarks are the property of their respective owners. Ahead of What's Possible is a trademark of Analog Devices. DN20995-0-1/19

analog.com



AHEAD OF WHAT'S POSSIBLE™